



TAURUS
INTERNATIONAL
CONSULTANCY & TRADE



Mustafa Kemal Mah. Dumlupınar Bulv.
Tepe Prime No:266A/18 Çankaya -Ankara
TÜRKİYE



+90 312 911 88 63



info@taurusinternationaltrade.com



www.taurusinternationaltrade.com



Meriç SÜLÜ
Co-founder

 meric.sulu@taurusinternationaltrade.com



Bülent CANSU
Co-founder

 bulent.cansu@taurusinternationaltrade.com



TAURUS
INTERNATIONAL
CONSULTANCY & TRADE

- **Professional consultancy in bilateral trade relationship**
- **Manufacturer supply in the energy and machinery sectors**
- **Working languages:**
 - French
 - English

About us

As a reliable partner in trade with our team members specialized in their fields, we offer trade consultancy services for various sectors, especially energy and machinery.



Our Vision

We aim to provide solution-oriented professional services that are accurate, reliable and in line with ethical values.

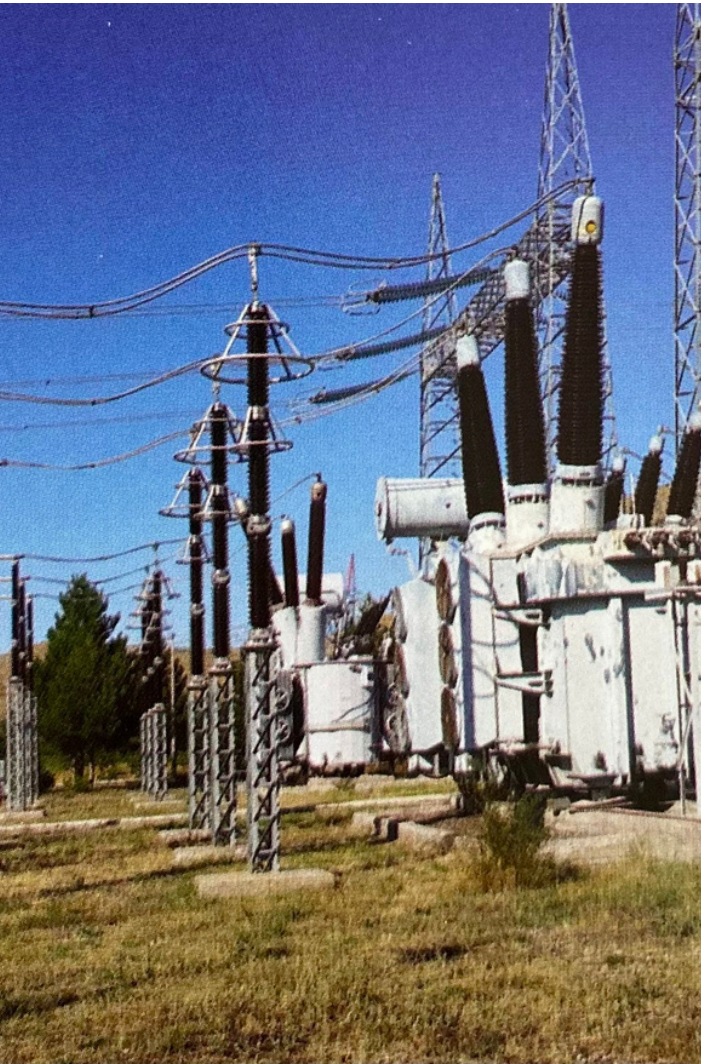

Our Mission

Our principle is to exceed our customers' expectations with sectoral expertise by prioritizing sustainable growth and industrial development.





MV DISTRIBUTION TRANSFORMERS

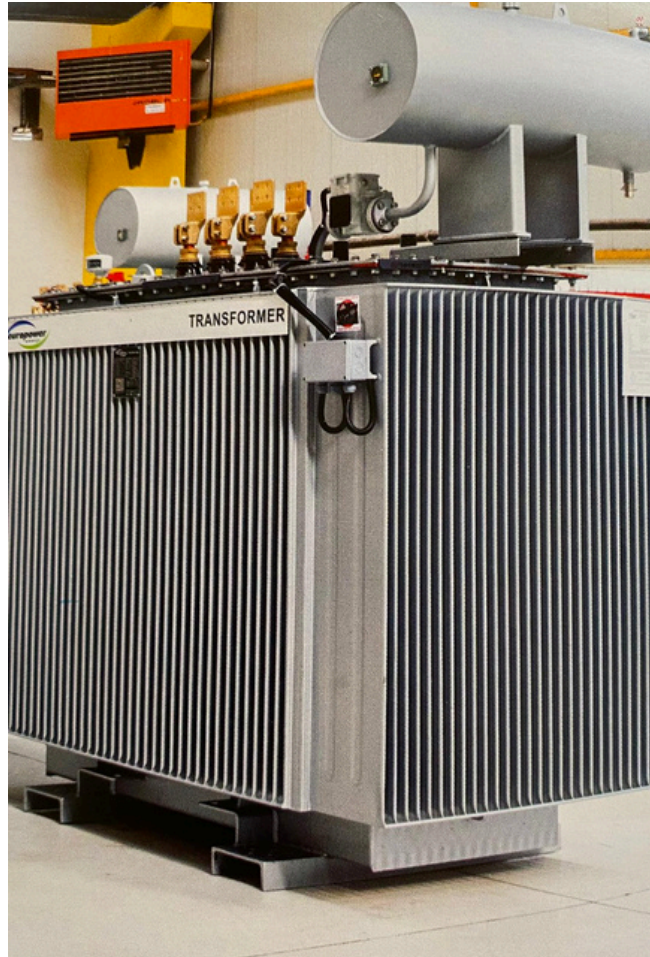

- Rated power: 10-31,500kVA
- System voltage: max.66kV
- Cooling: ONAN,KNAN,ONAN/ONAF,KFAF
- Coolers: corrugated wall or radiator
- Hermetically sealed or conservator/free breathing
- Off-circuit tap changer or on-load tap changer
- Cooling: mineral, FR3, midel oil
- Steel type core damping system
- High voltage (HV) multilayer winding
- Low voltage (LV) foil winding or layer winding
- Winding materials aluminum or copper
- High temperature class transformers
- Low noise solution
- Efficient transformers with very low losses





TRANSFORMER KIOSKS



With top and bottom
connections
With single or double
transformers
Heavy duty type





MOBILE SUBSTATIONS



Solutions for every need with
different configurations
HV-MV, MV-MV, MV-LV

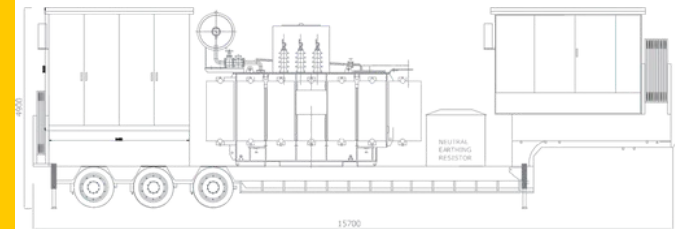



KIOSKS SANDWICH PANEL CONSTRUCTION



For solar power plants

For wind power plants

For transformer substations

For hard transportation zones

Light weight kiosk

Fire-resistant construction

Basement free





CIRCUIT BREAKER SWITCHBOARDS



Outdoor Type





CONCRETE KIOSKS



Monoblock





MV COMPONENTS

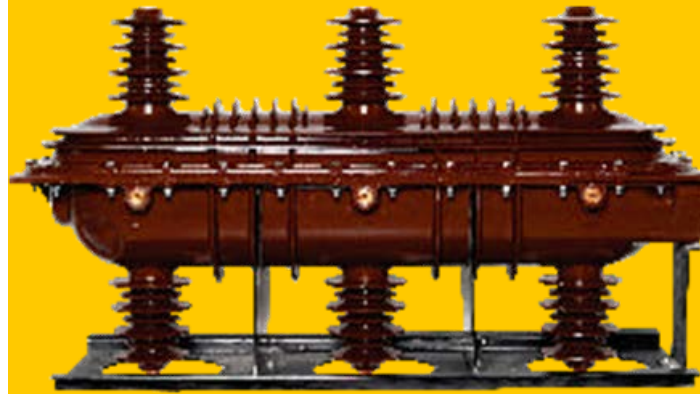

Disconnectors & Load Break Switches

Up to 36kV, 1250A and 25kA,

Circuit Breakers

Up to 36kV, 1250A and 25kA

Compact, reliable, smartly simple
and easily adapted SF6
disconnectors and load break
switches .

Compliant to international
standards, with many available
options and accessories.

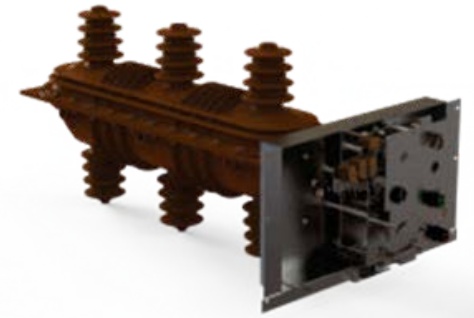



MV COMPONENTS



Metal-enclosed air-insulated
modular switchboard panels
Modular structure
Tailor made configuration
Internationally type-tested up to
36kV, 1250A and 25kA,





SOLAR MODULES



PPV144-530W-550W
MONOCRYSTALLINE PERC MODULE

144 CELL

Mono PERC Module

1500 VDC

Maximum System Voltage

530-550 Wp

Power Output Range

21.3%

Maximum Efficiency





MOUNTING SYSTEMS FOR PV POWER PLANTS

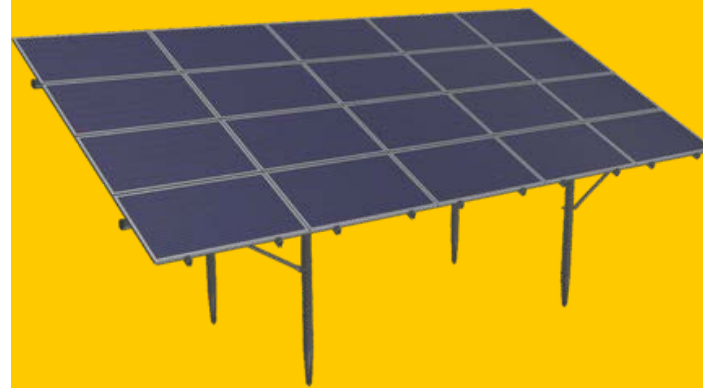

Reliable and efficient systems for all
types of soil and ground conditions
Modular and cost optimized
structure, suitable for a wide range
of configurations

Exceptional soil holding properties,
high supporting capacity
Perfect synchronization between
system components





LV PANELS

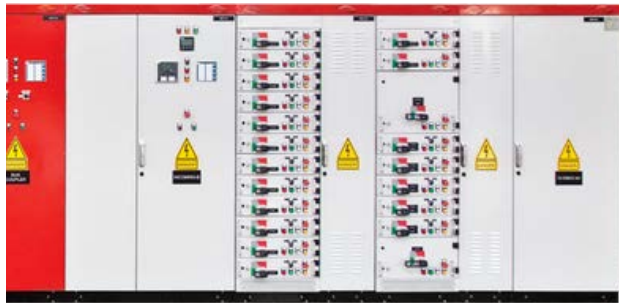

Power Distribution Panels

Up to 6300A /65KA

IP55 FORM 4B

Drawer/fixed type panel

LV Power Compensation Panels

Industrial Panels

MCC Panels

AC/DC Distribution Panels

Main/Field Collection Panels for

Solar Power Plants





GENERATORS

SDEC

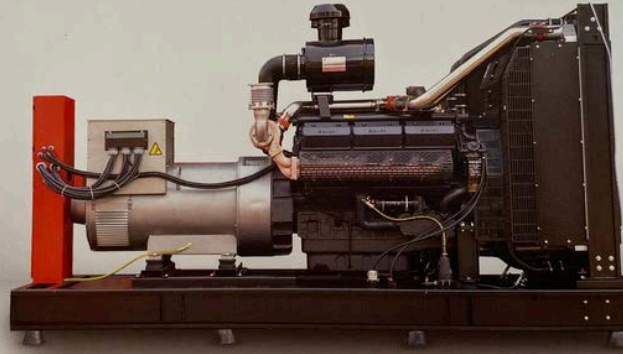

Perkins

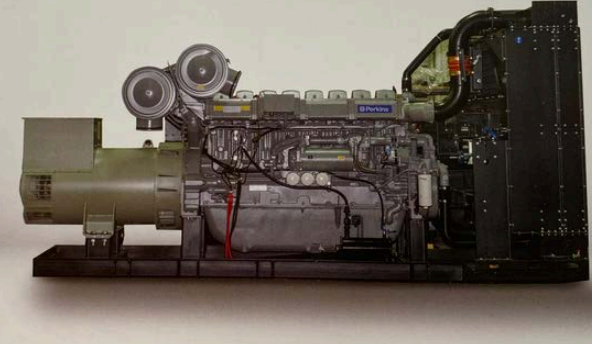

Motor Options

PERKINS series 10-2500kVA

BAUDOUIIN series 20-2750 kVA

MITSUBISHI series 8-2500 kVA

CUMMINS series 28-2500 kVA

SDEC series 66-1100 kVA

QUANCHAI series 12-120 kVA

Portable Generators: 2-11 kW

Cummins



Baudouin



QUANCHAI
全柴

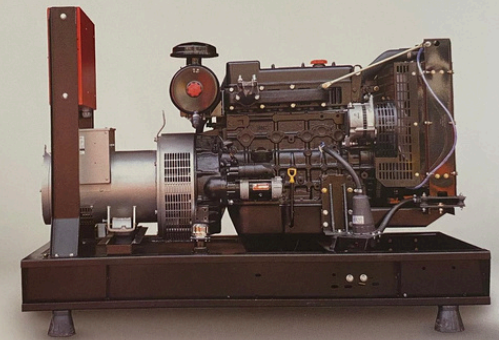

Alternator Options

LINZ

STAMFORD

We hope to establish with your company a strong business relationship grounded on cooperation, trust and friendship...



info@taurusinternationaltrade.com



www.taurusinternationaltrade.com



TAURUS
INTERNATIONAL
CONSULTANCY & TRADE

The logo features a stylized bull with a geometric, low-poly design in shades of grey and black, facing left. The bull is positioned to the right of the text. The text is in a clean, sans-serif font, with 'TAURUS' and 'INTERNATIONAL' in larger sizes, and 'CONSULTANCY & TRADE' in a smaller size below them.